

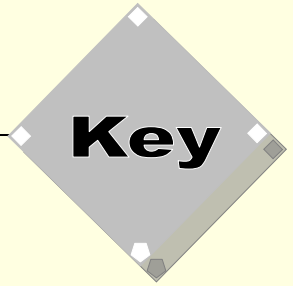

Confederation of European Baseball
Confédération Européenne de Baseball

1 Man System



Symbols explanation

Umpires

UIC Umpire in Chief

Movement



Pause



Position



Runners situations

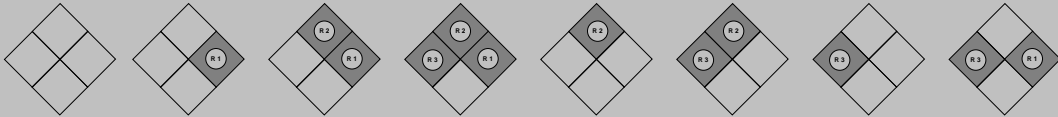

Batted ball



Out situations



Offense

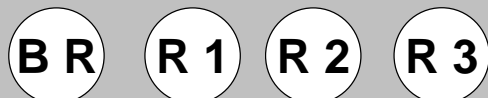

Defense



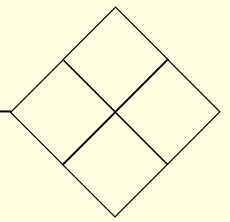
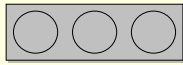

Situation #1
Ground ball with assist to first base

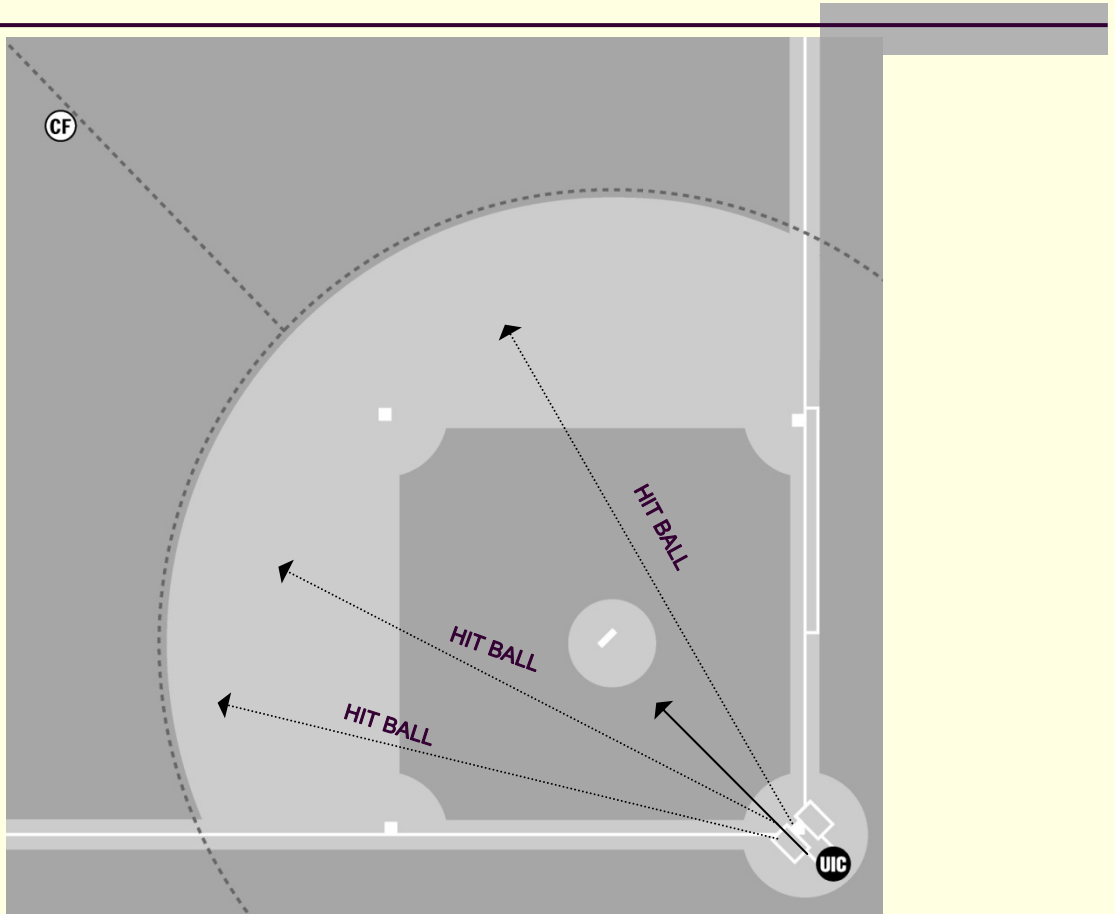

UIC The umpire moves towards the mound to a position that will allow a good angle to view the play at first.

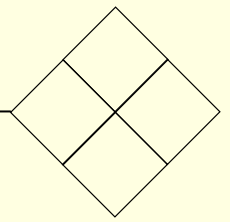
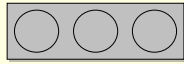

Situation #2 Infield assist with missed ball

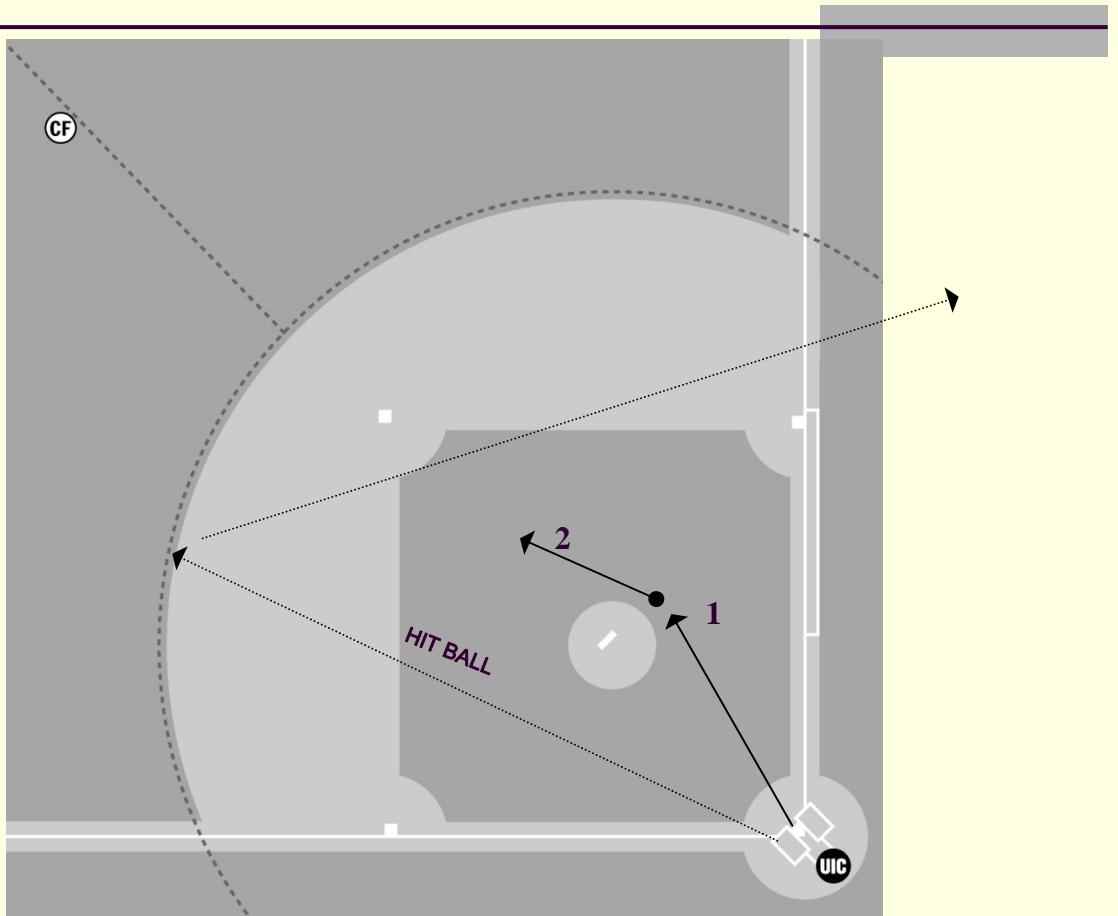

UIC The umpire moves towards the mound to a position that will allow a good angle to view the play at first.

IT COULD HAPPEN:

1. Batter-runner returns to first base, the umpire moves towards first base.
2. Batter-runner goes to second base, the umpire turns around the mound and moves towards second base.

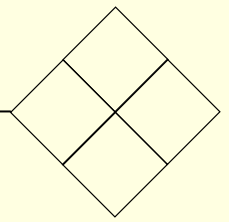
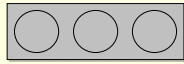

Situation #3

Fly ball or hit to deep right field

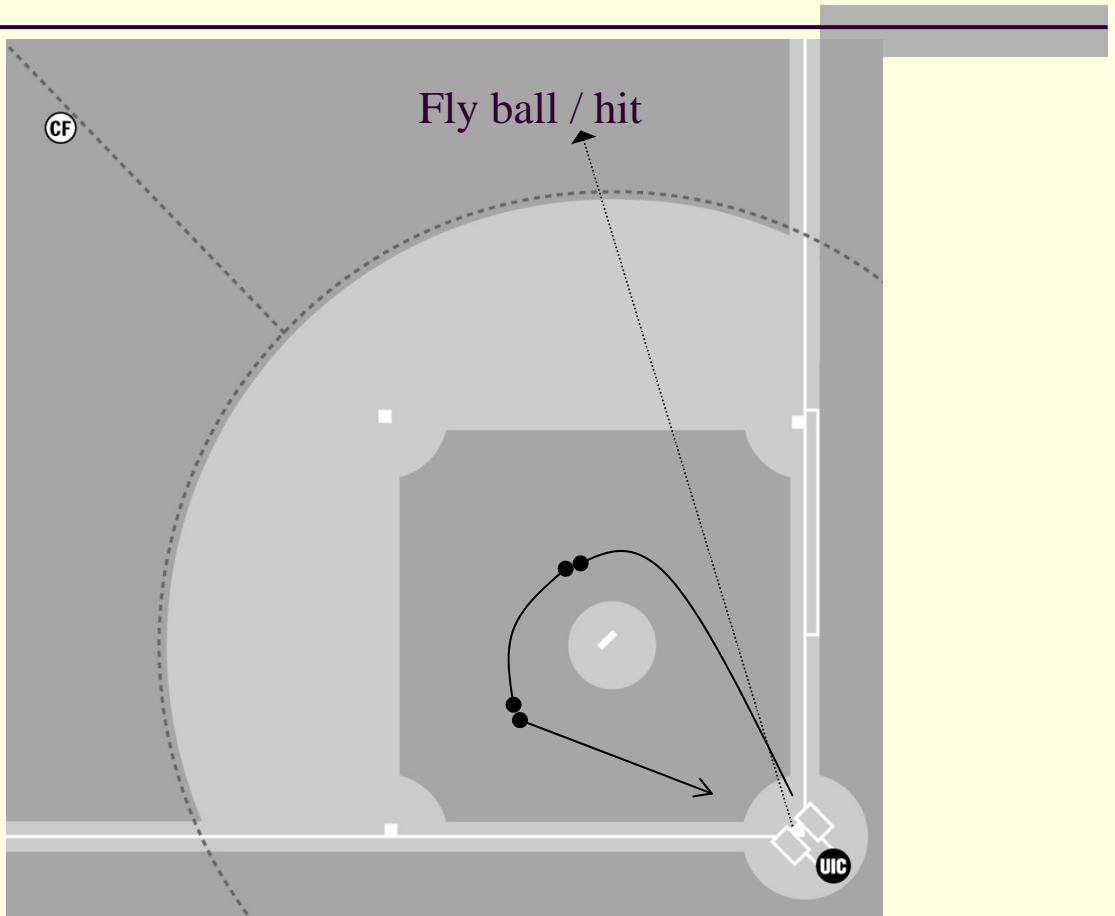

UIC The umpire moves along the foul line and rules:

- Fair or foul.
- Catch or no catch.
- In case of subsequent play the umpire turns around the mound, checks BR touch and takes position for all possible plays at all bases.

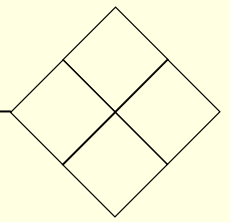
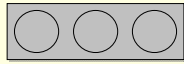

Situation #4
Hit to center field

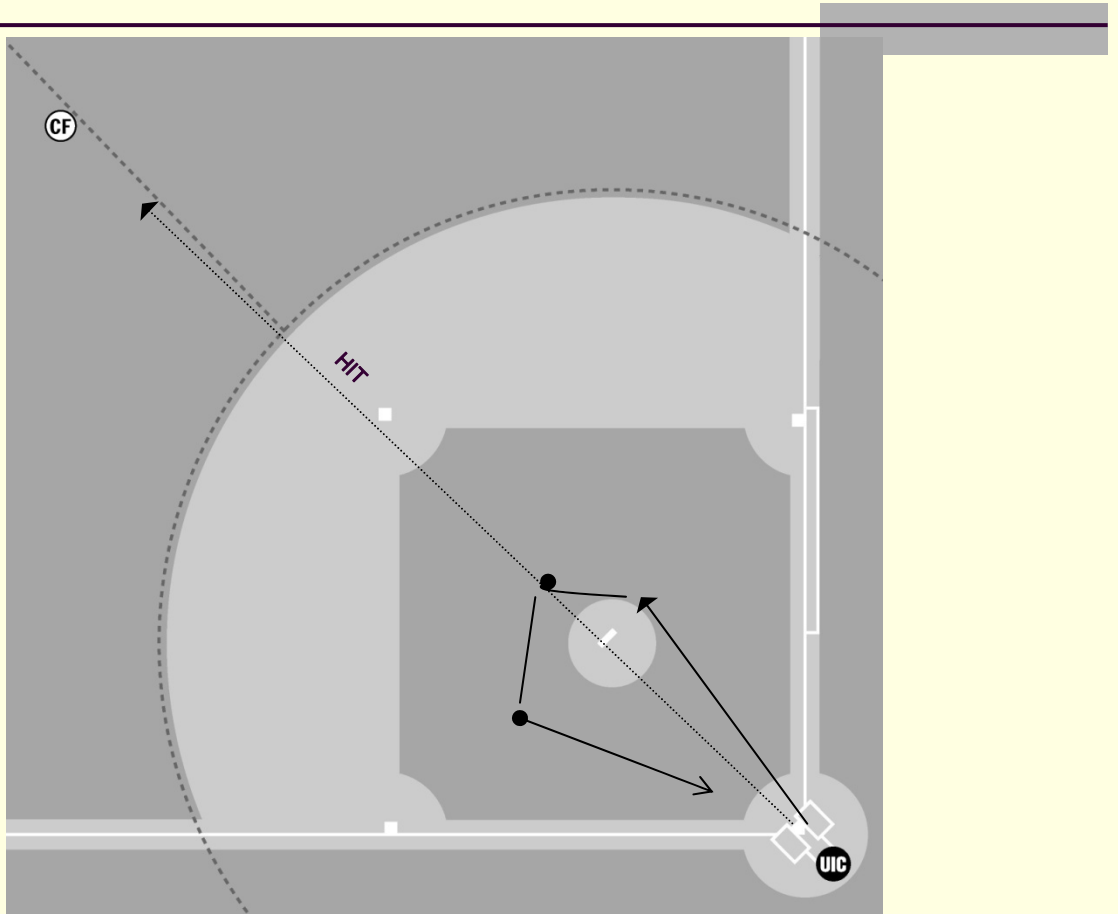

UIC The umpire moves towards the infield then turns around the mound and takes position for all possible plays at all bases.

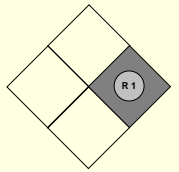
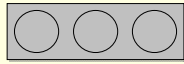

Situation #5
R1 steals second

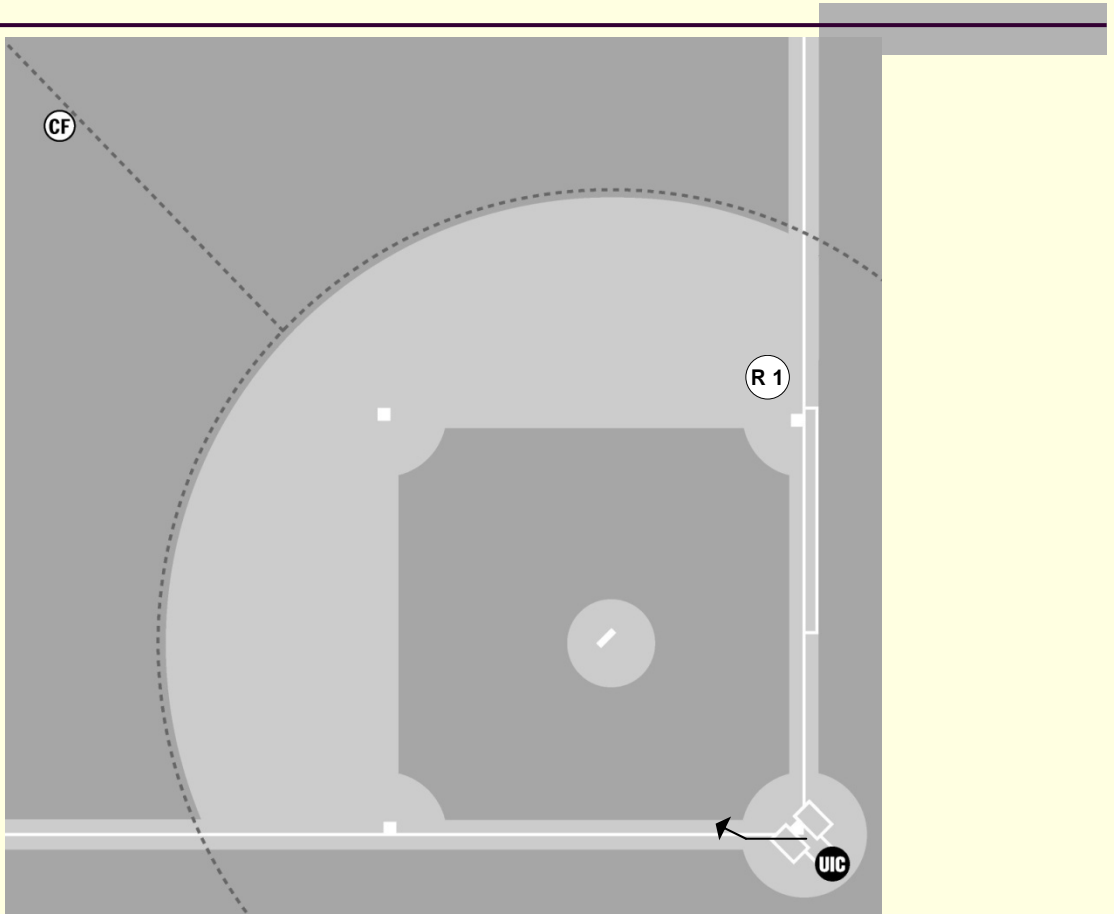

UIC The umpire takes a few steps towards the infield to a position that will allow a good angle to view the play.

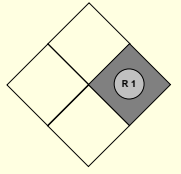

Situation #6 Double play ground ball

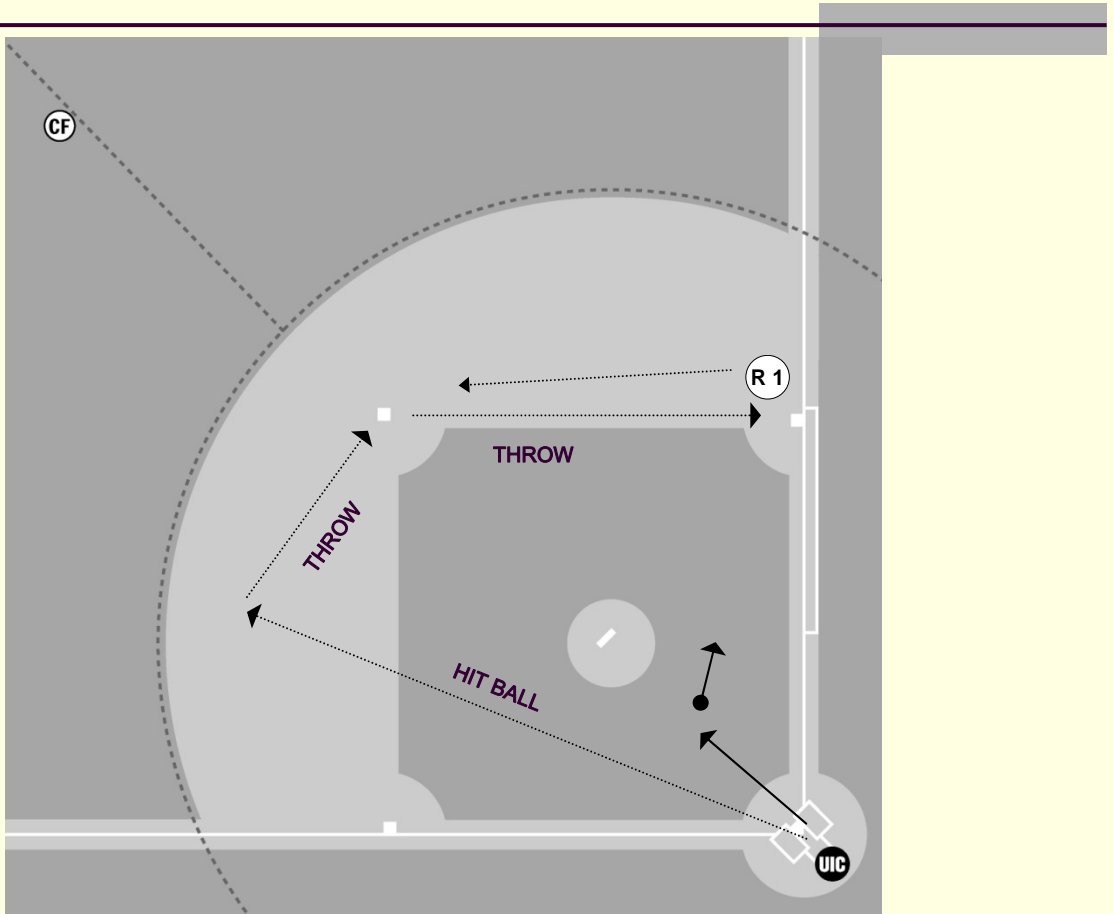

UIC The umpire moves towards the infield, rules the play at second and takes a step towards first for the second play.

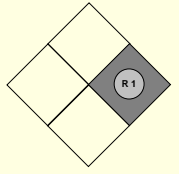
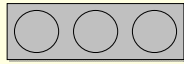

Situation #7

Ground ball to the infield and bad throw by an infielder over the first base

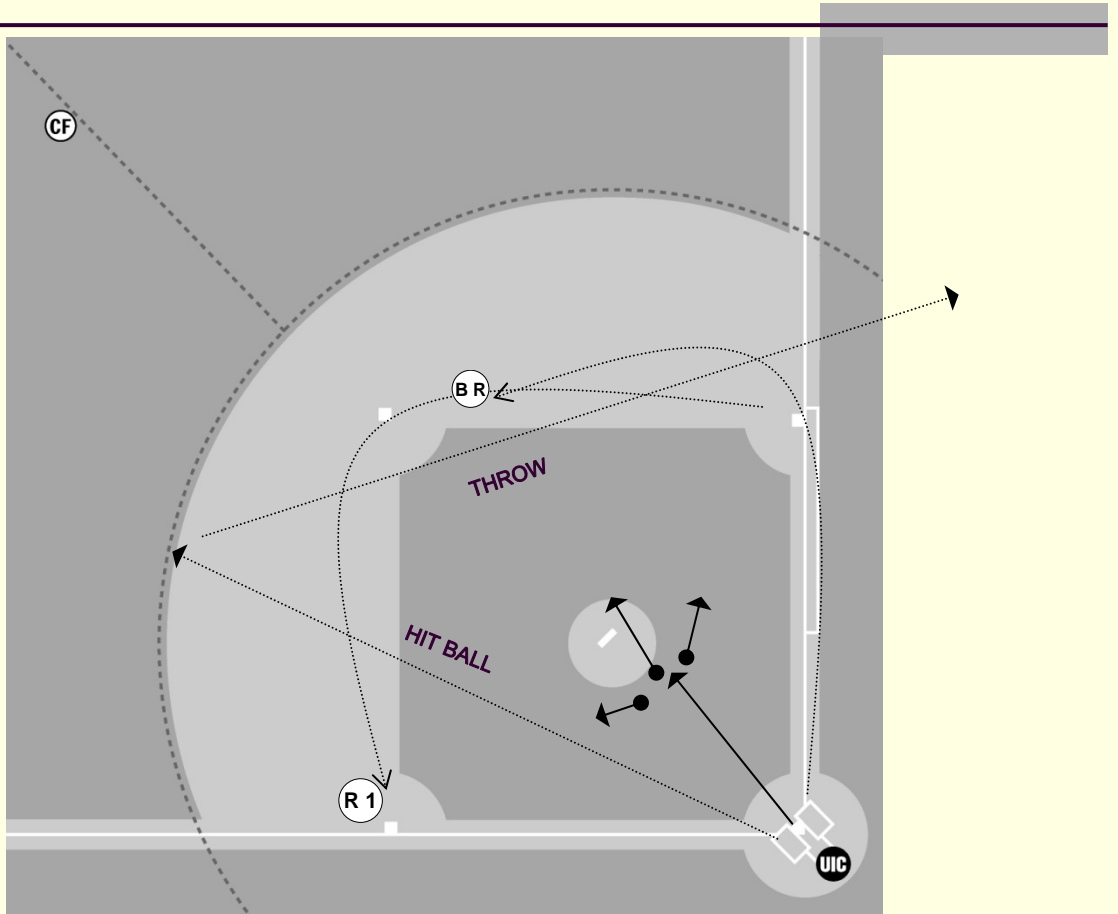

UIC The umpire moves towards the mound to a position that will allow a good angle to view all the possible plays at all bases.

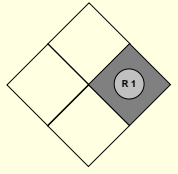
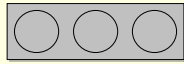

Situation #8
Batted ball down the right field line
R1 advancing to third base

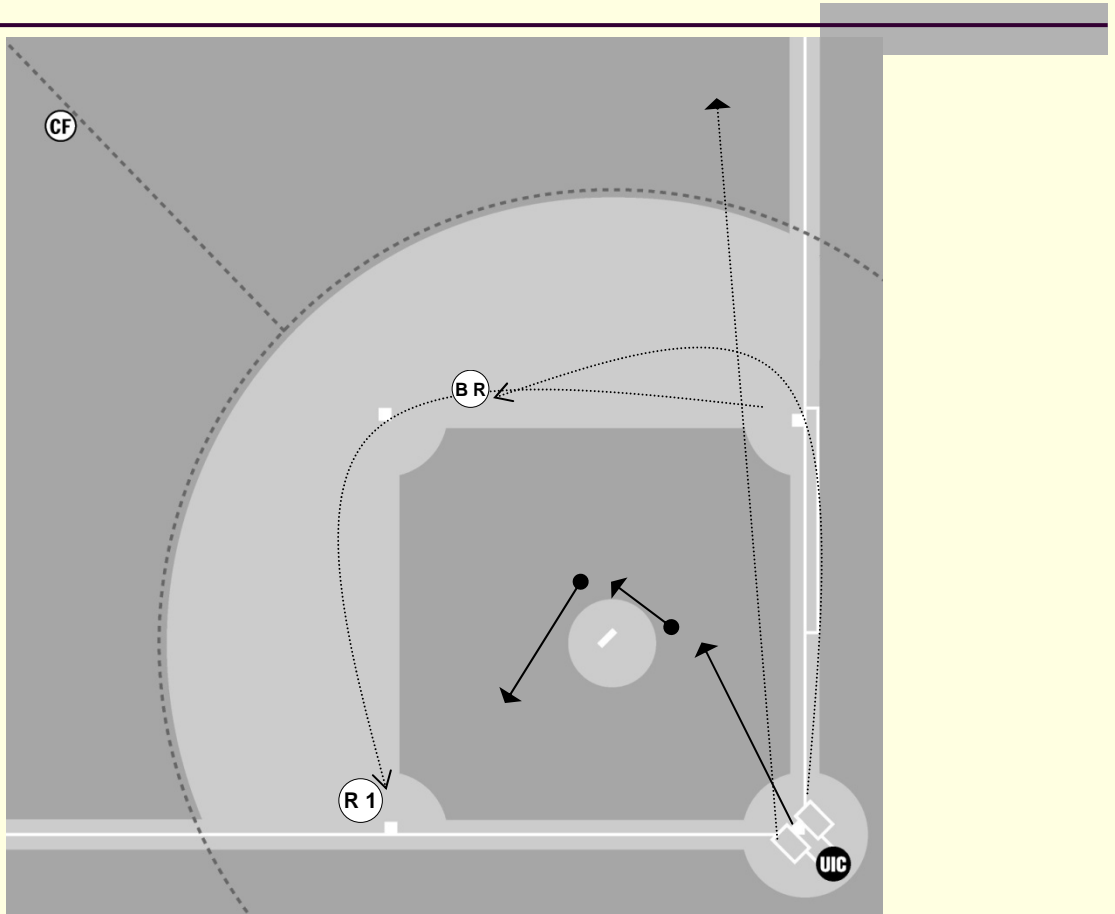

UIC The umpire must rule:

- Fair or foul
- Catch or no catch
- In case of hit the umpire checks runners touch and is ready to take position for all the possible plays.

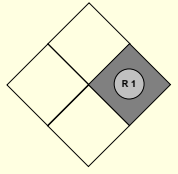
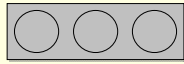

Situation #9 Batted ball down the left field line

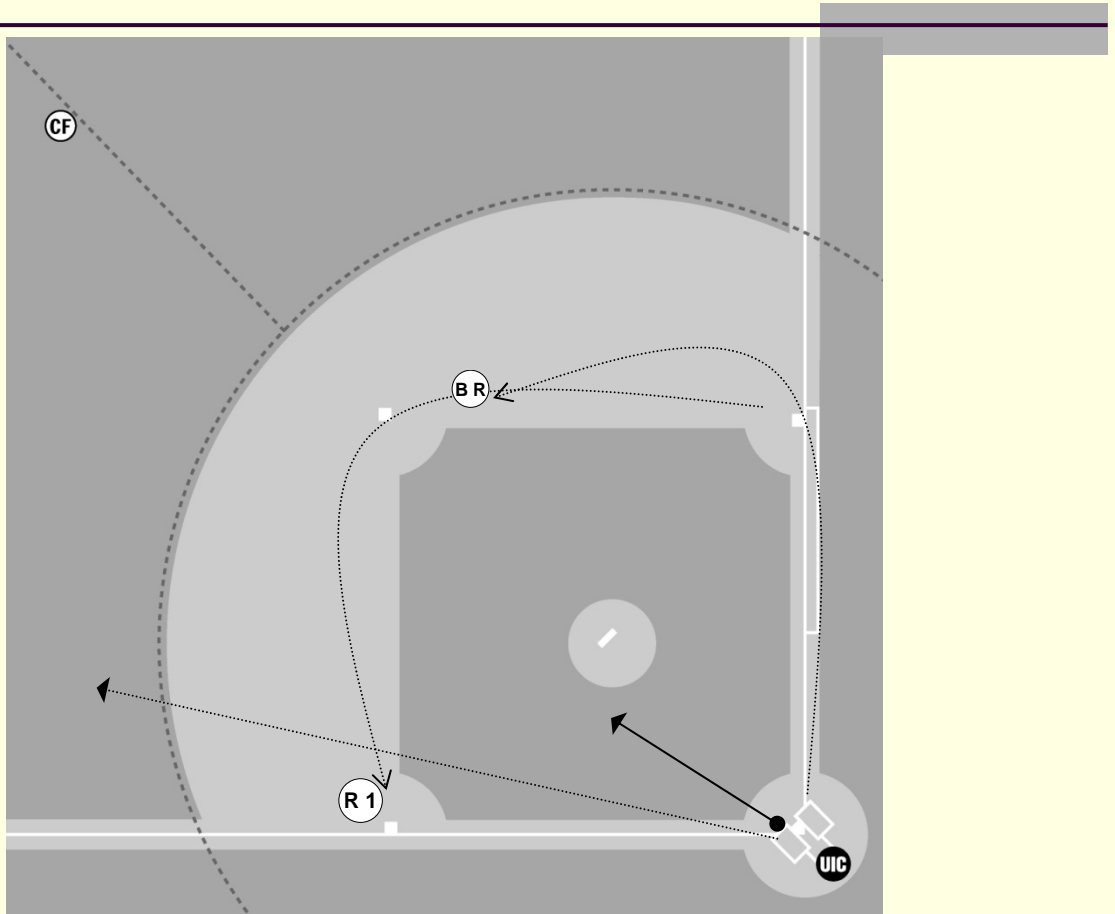

UIC The umpire must rule:

- Fair or foul
- Catch or no catch
- In case of hit the umpire checks runners touch and is ready to take position for all the possible plays.

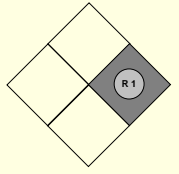
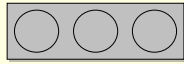

Situation #10

Fly ball with runner tagging

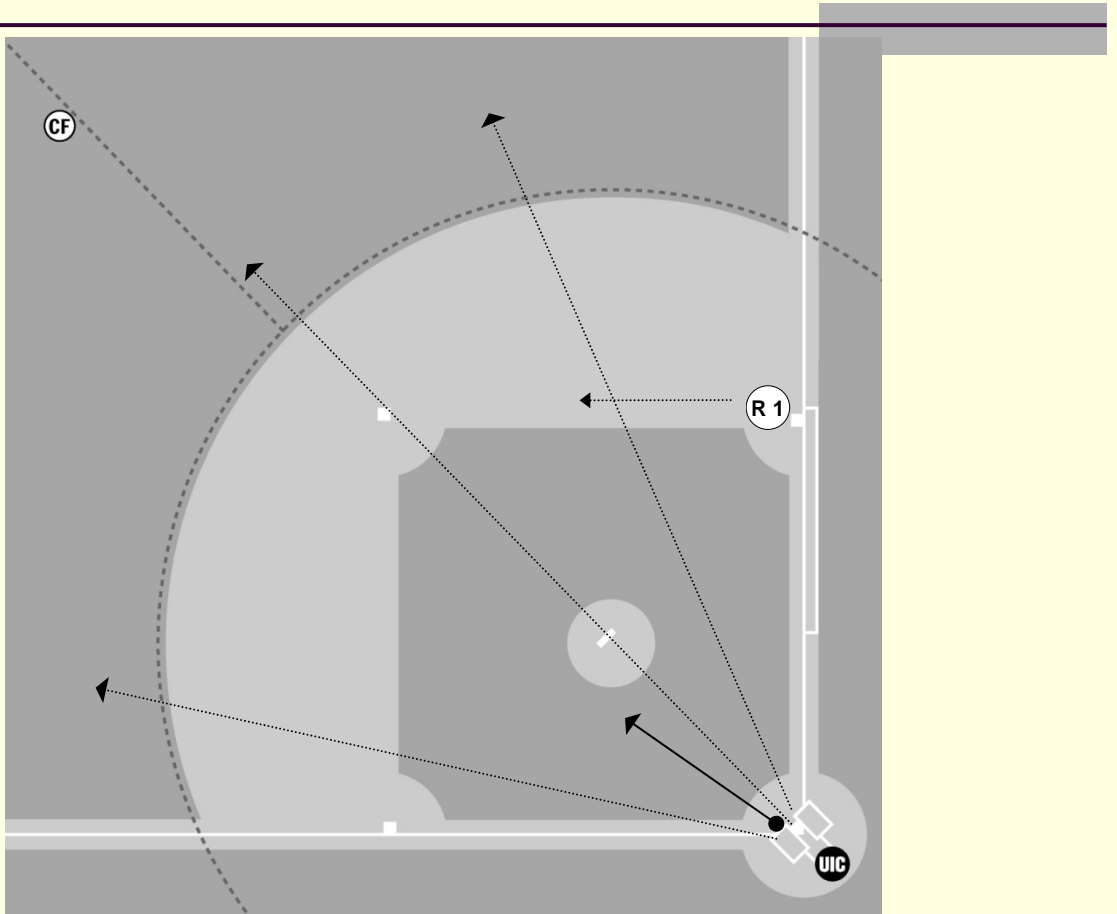

UIC The umpire moves towards the mound to a position that will allow a good angle to view the catch and checks the runner tag. Then he moves towards the base for the play.

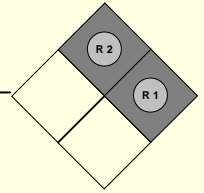
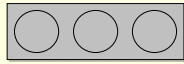

Situation #11 Ground ball to the infield

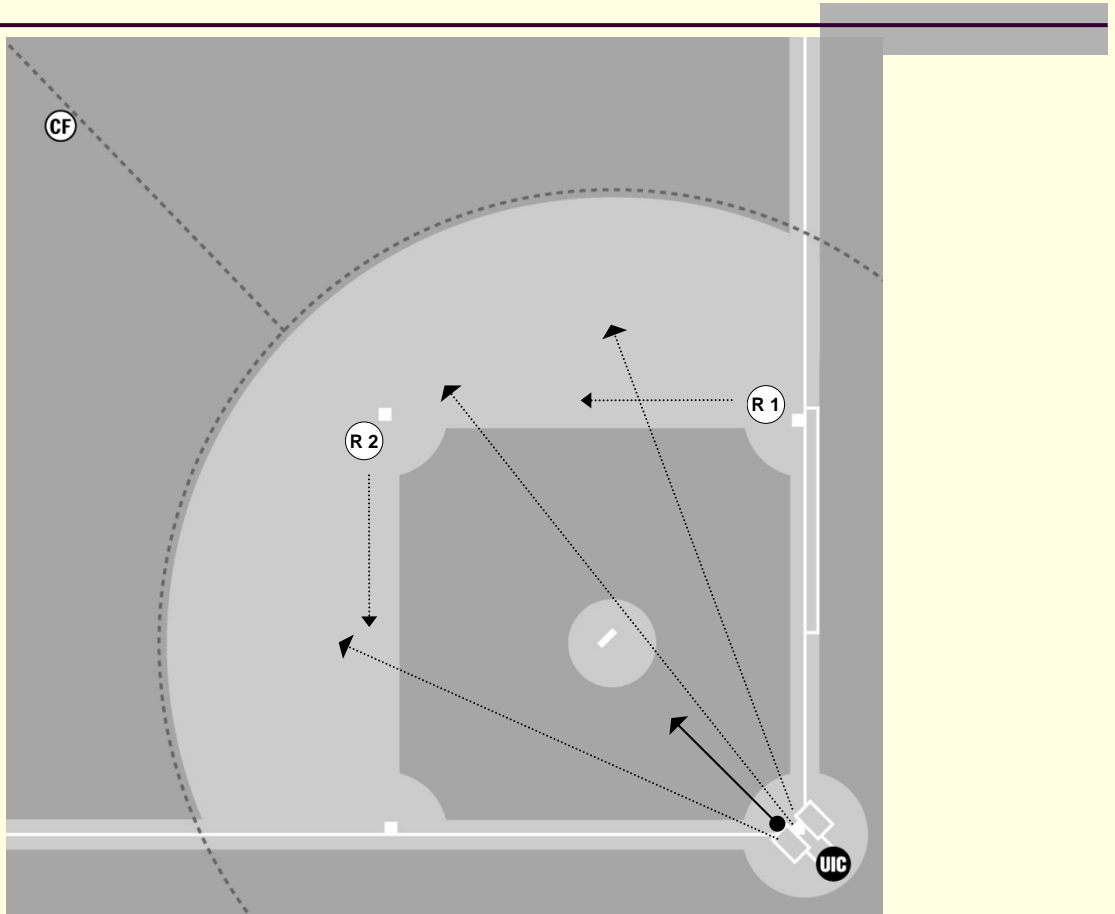

UIC The umpire moves towards the infield to a position that will allow a good angle to view all the possible plays at all bases.

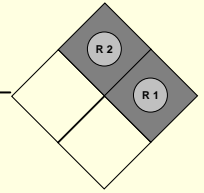
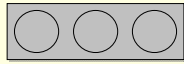

Situation #12 Batted ball down the right field line

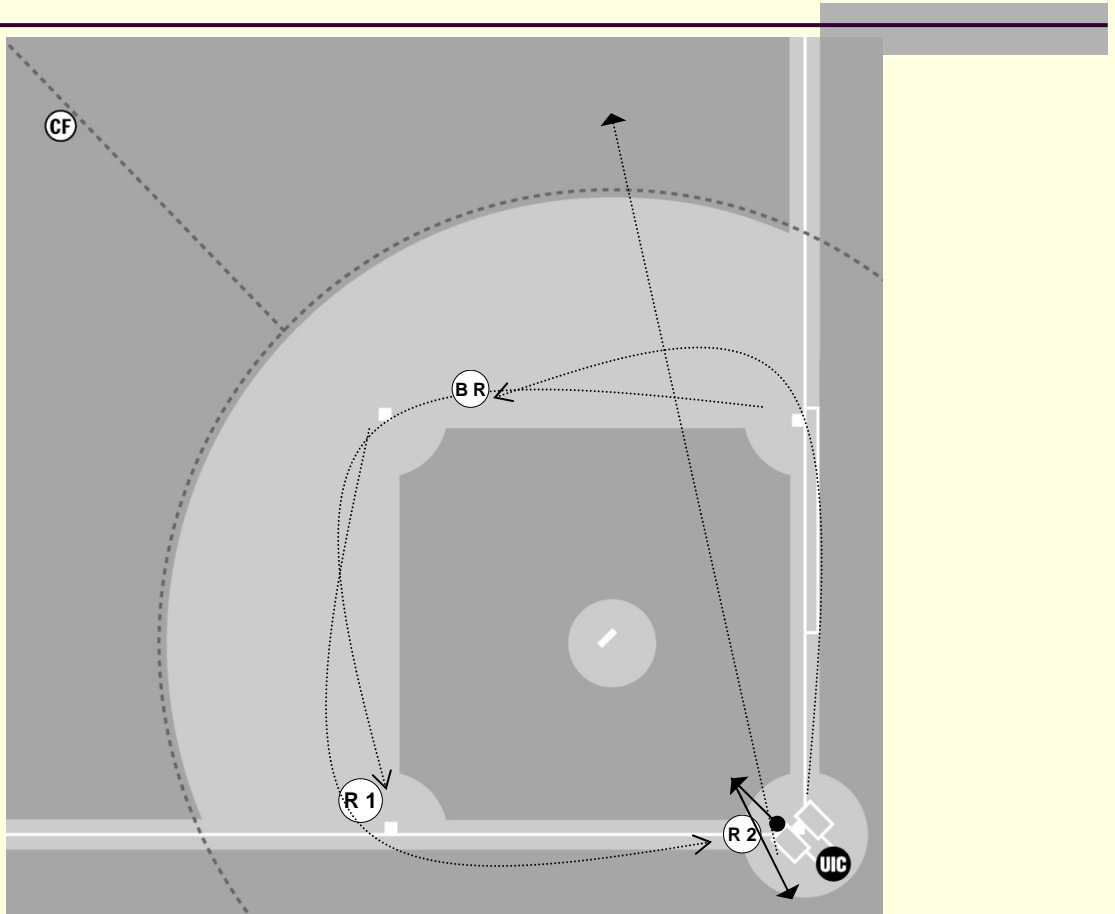

UIC The umpire must rule:

- Fair or foul
- Catch or no catch
- Runners tag
- Runners touch
- Plays at all bases
- In case of play at home he must come back and look for the best angle to view the play

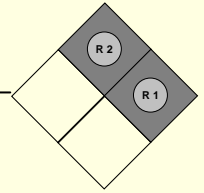
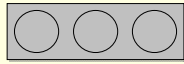

Situation #13 Batted ball to center field

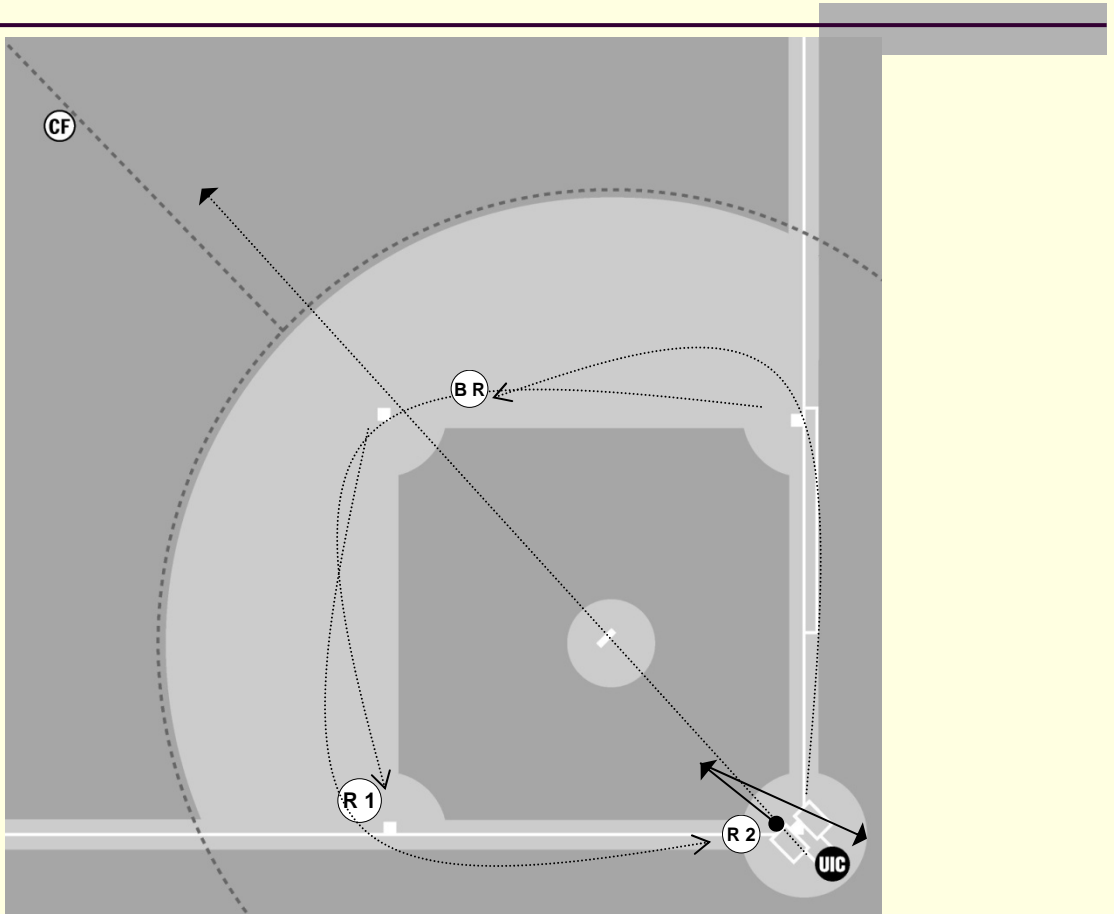

UIC The umpire must rule:

- Catch or no catch
- Runners tag
- Runners touch
- Plays at all bases
- In case of play at home he must come back and look for the best angle to view the play

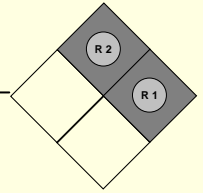
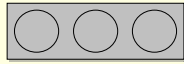

Situation #14 Batted ball down the left field line

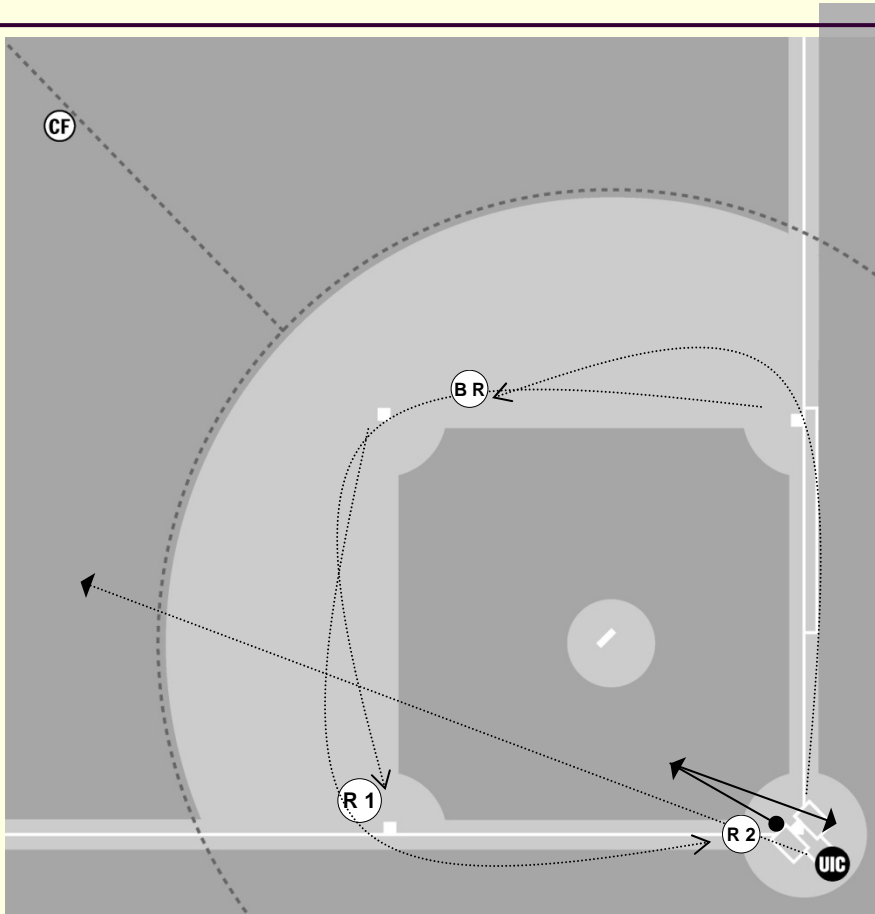

UIC The umpire must rule:

- Fair or foul
- Catch or no catch
- Runners tag
- Runners touch
- Plays at all bases
- In case of play at home he must come back and look for the best angle to view the play

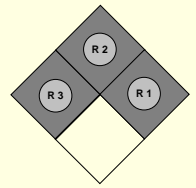
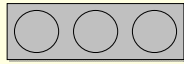

Situation #15 Hit

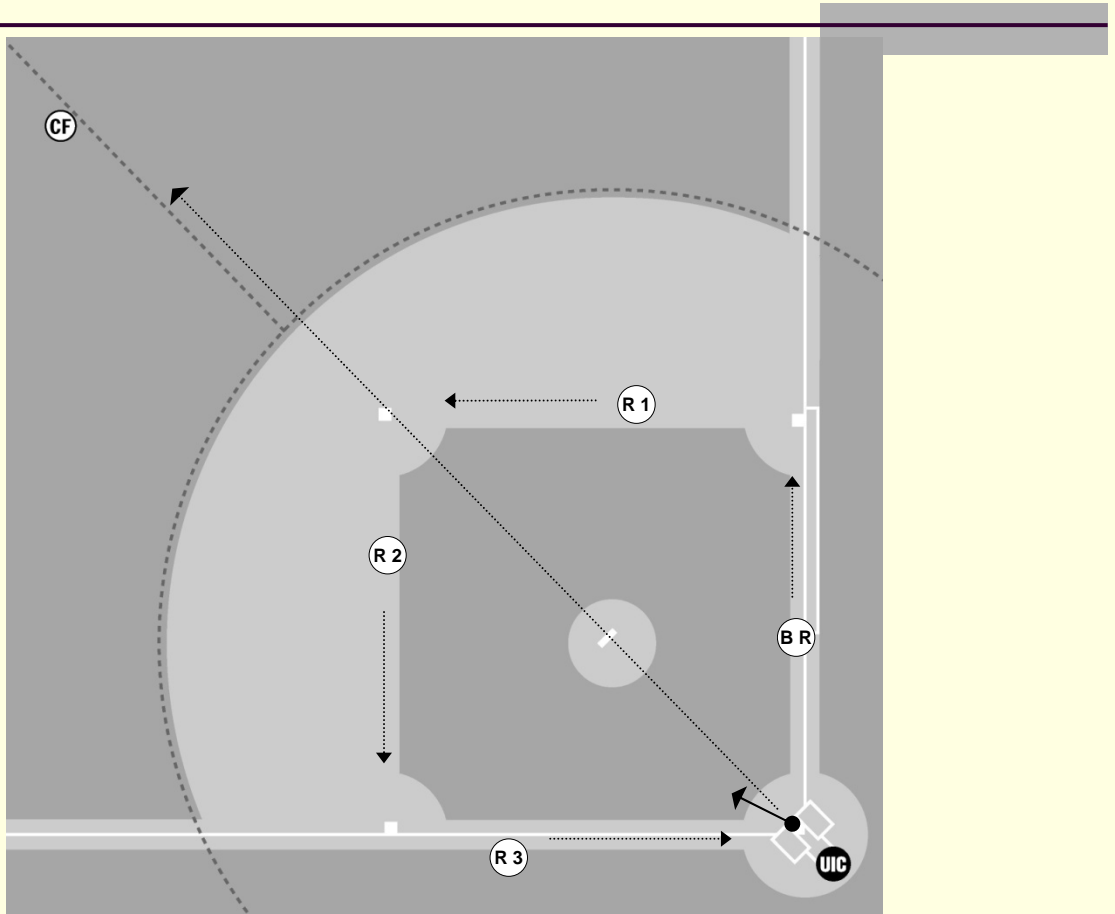

UIC The umpire moves towards the mound, checks runners touch and then moves towards the base at which is the play.

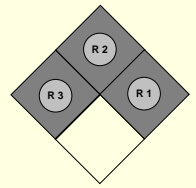

Situation #16 Fly ball to the outfield

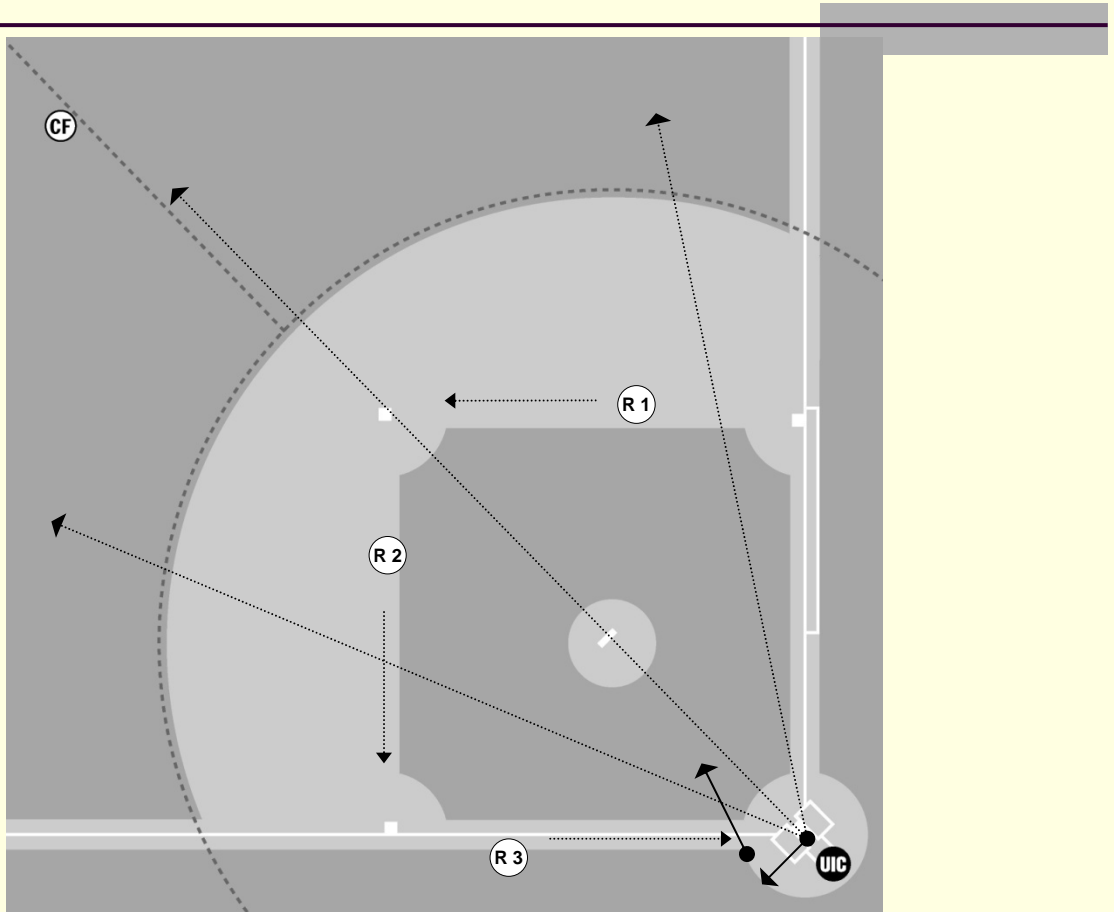

UIC The umpire must rule:

- Fair or foul
- Catch or no catch
- Watches the runner tag at third
- In case of play at home he stays there, otherwise checks the touch at home and then takes a few steps towards the infield for all possible plays at all bases

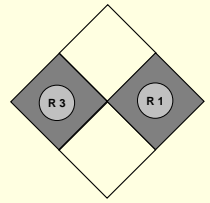
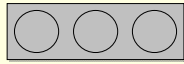

Situation #17 Ground ball to the infield

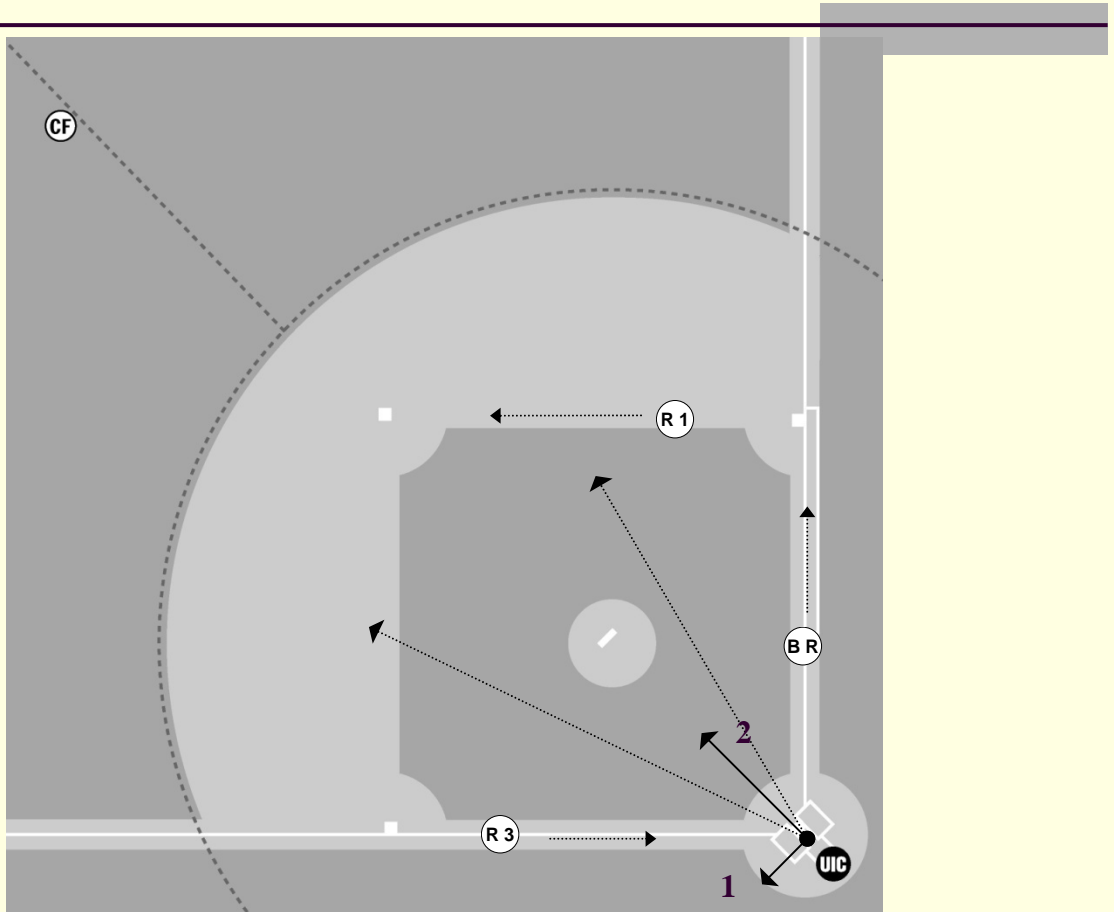

UIC The umpire reads the play and:

1. If the first play is at home, he takes position for the play at home and then moves towards the infield for subsequent plays.
2. If the first play is at second, at first, or a double play he moves towards the mound, spot checks the home touch and then moves towards the base at which is the play.

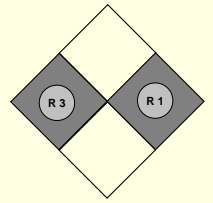

Situation #18 Fly ball to the outfield

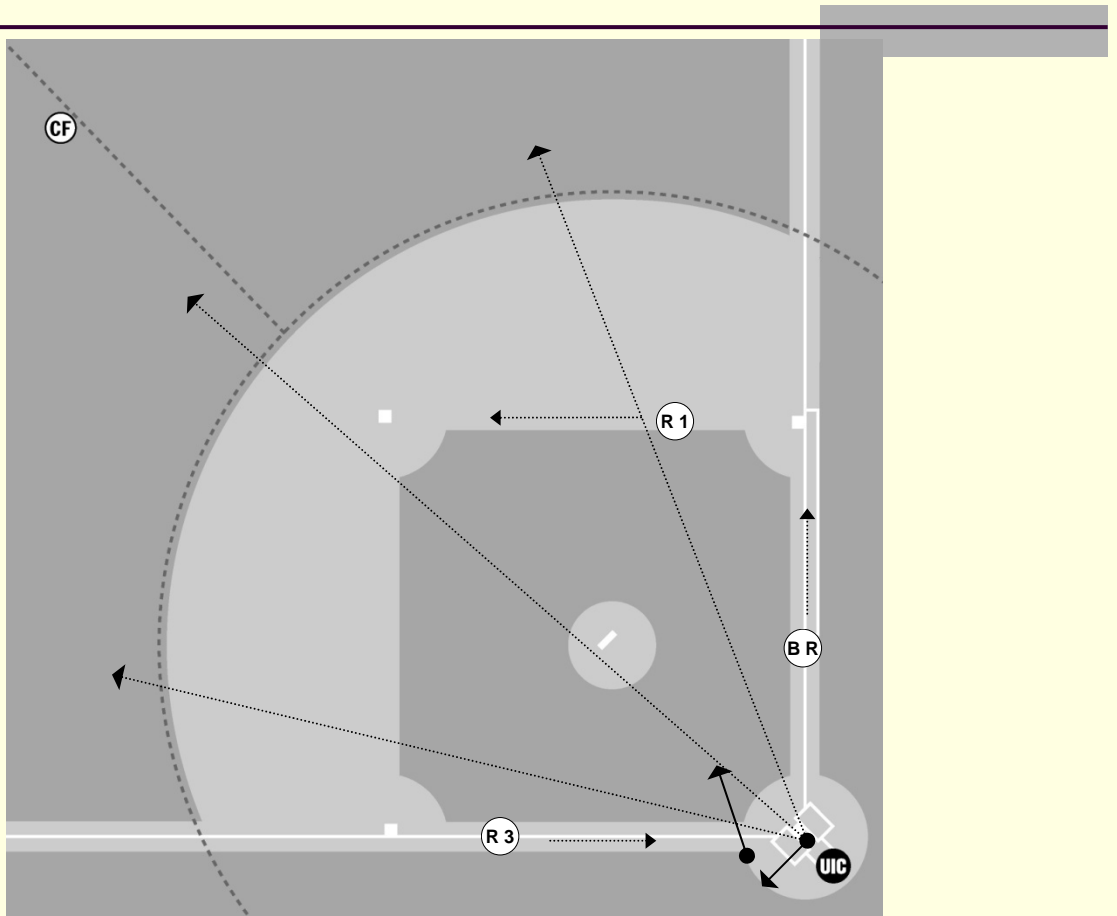

UIC The umpire must rule:

- Fair or foul
- Catch or no catch
- Watch the runner tag at third
- In case of play at home he stays there, otherwise checks the touch at home and then takes a few steps towards the infield for all possible plays at all bases

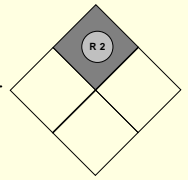
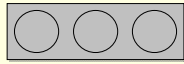

Situation #19 Ground ball to the infield

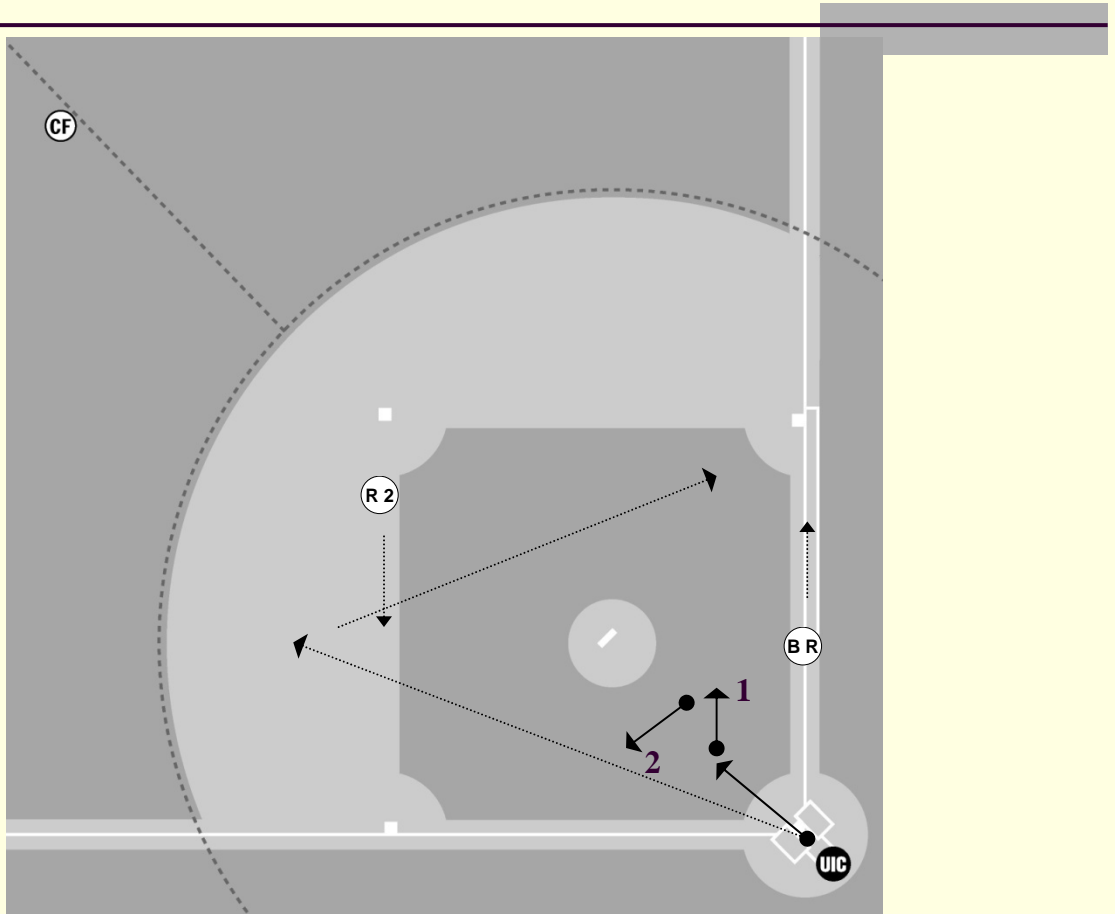

UIC The umpire moves towards the mound and:

1. looks for the best angle to view the play at first
2. in case of subsequent play on R2, takes a few steps towards the third

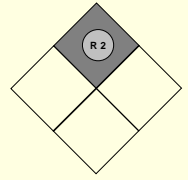
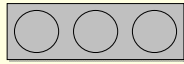

Situation #20 Hit

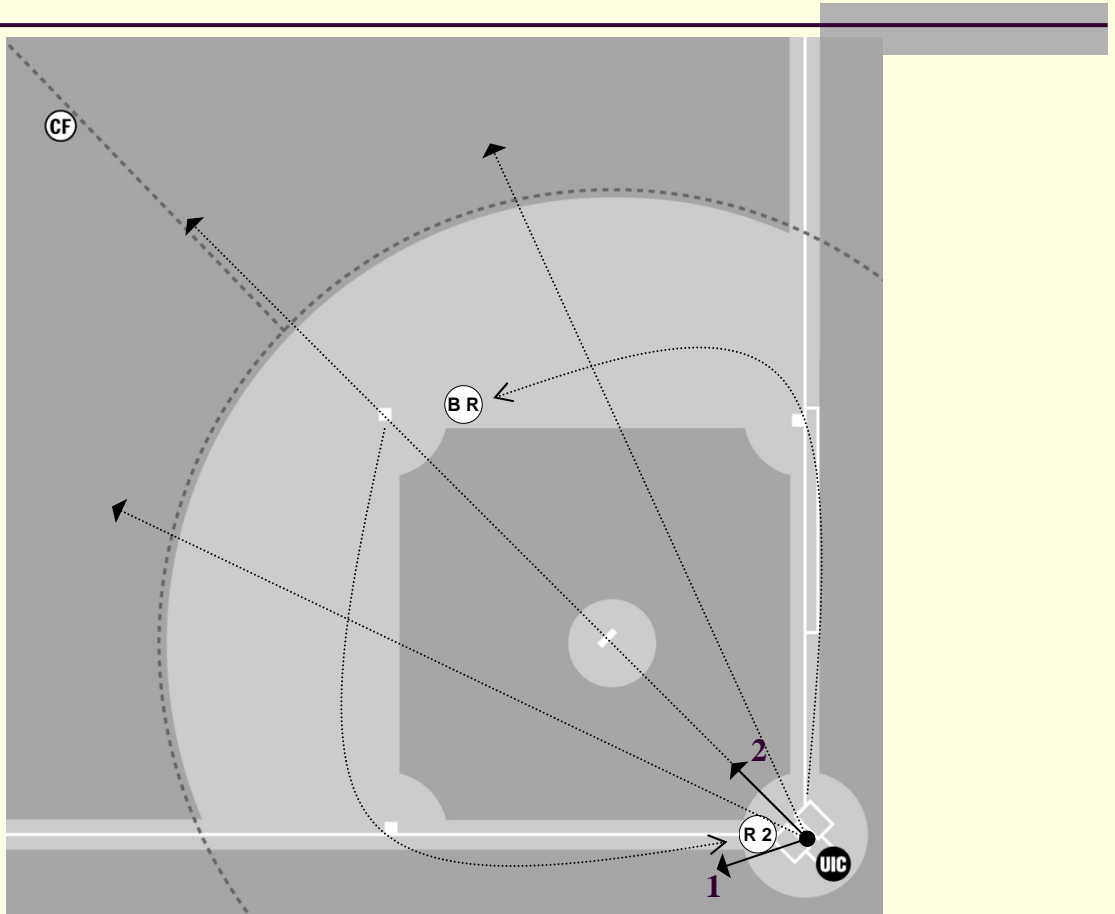

UIC The umpire reads the play and:

1. If the play is at home waits for R2 and then moves towards the mound.
2. If the play is on BR, first checks the home touch and then moves towards the base at which is the play.

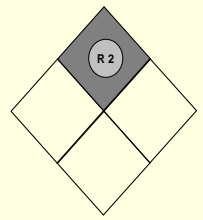

Situation #21 Fly ball to the outfield

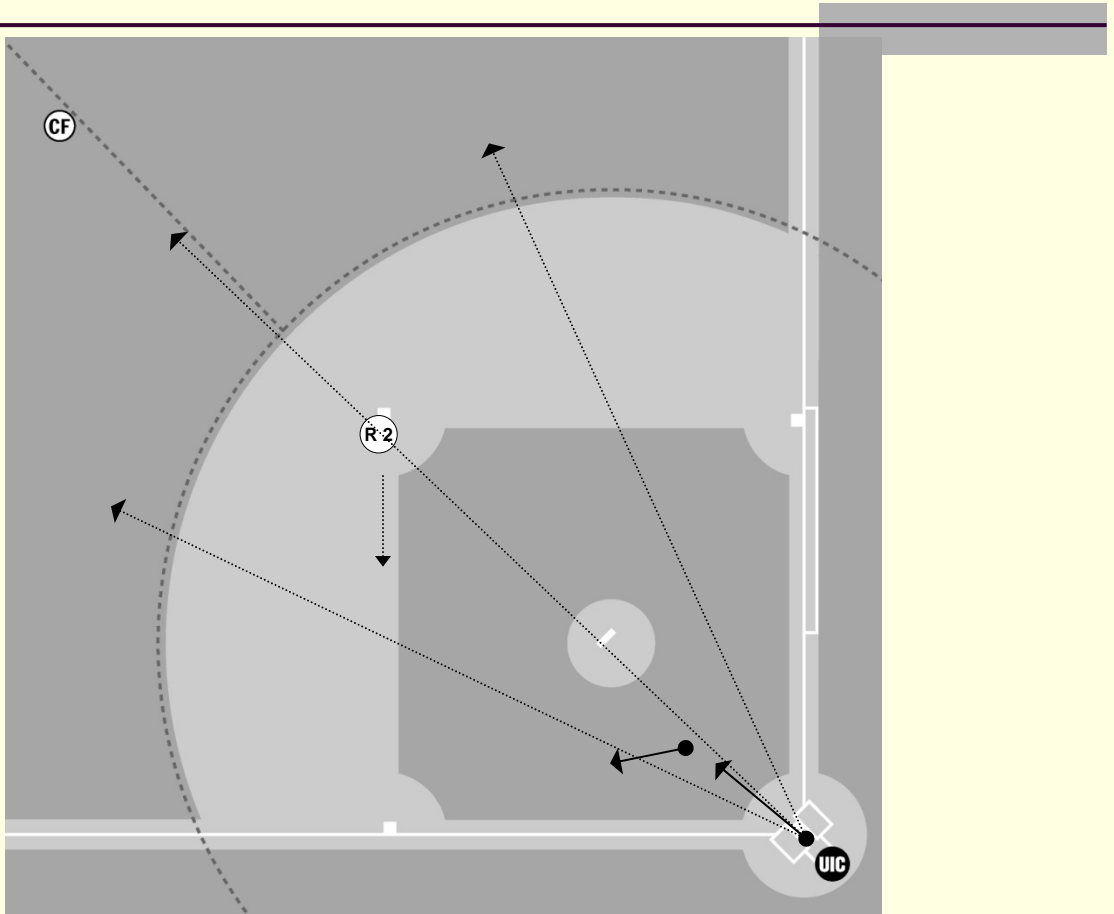

UIC The umpire must rule:

- Fair or foul
- Catch or no catch
- Watches the tag at second
- In case of play at third moves towards the base.

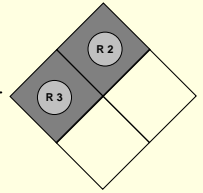
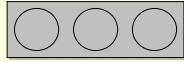

Situation #22 Ground ball to the infield

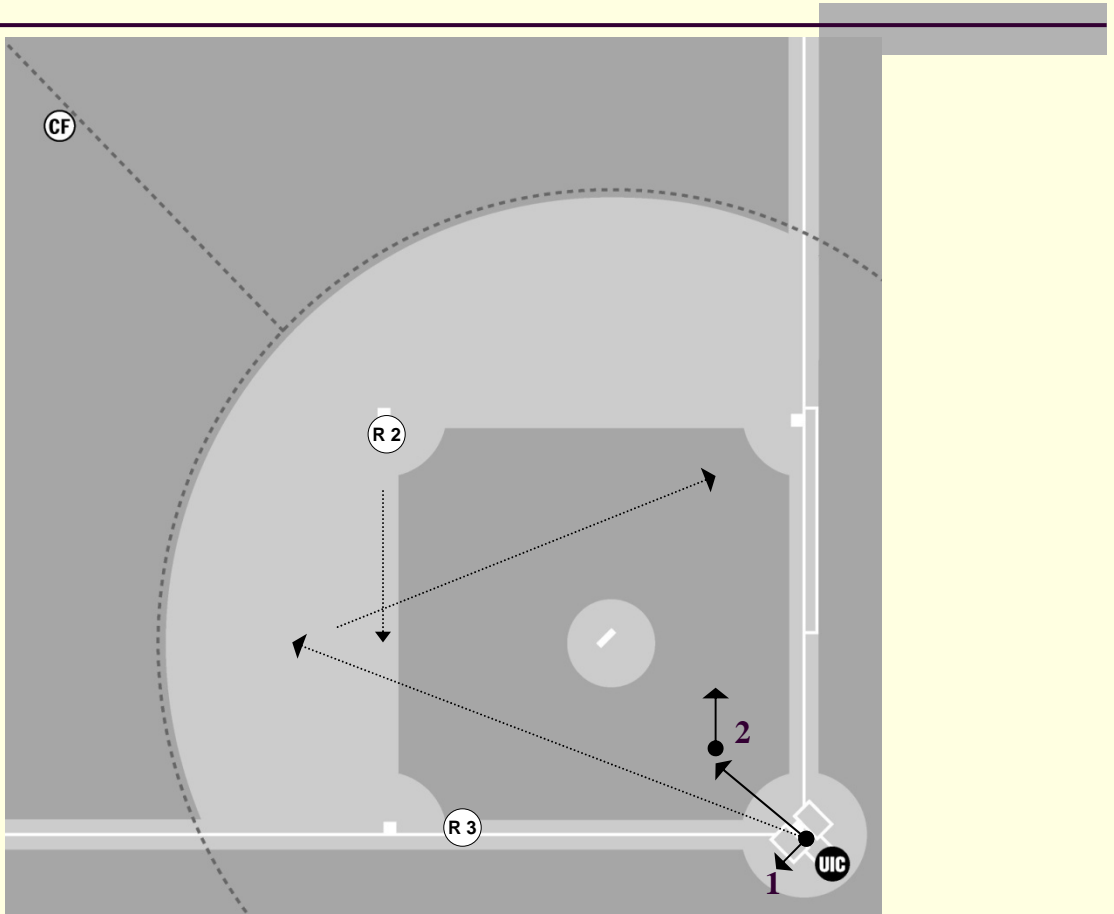

UIC The umpire reads the play and:

1. If the first play is at home, he takes position for the play at home and then moves towards the infield for subsequent plays.
2. If the first play is at another base he moves towards the mound, spot checks the home touch and then moves towards the base at which is the play.

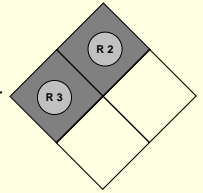
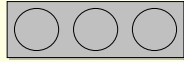

Situation #23 Hit

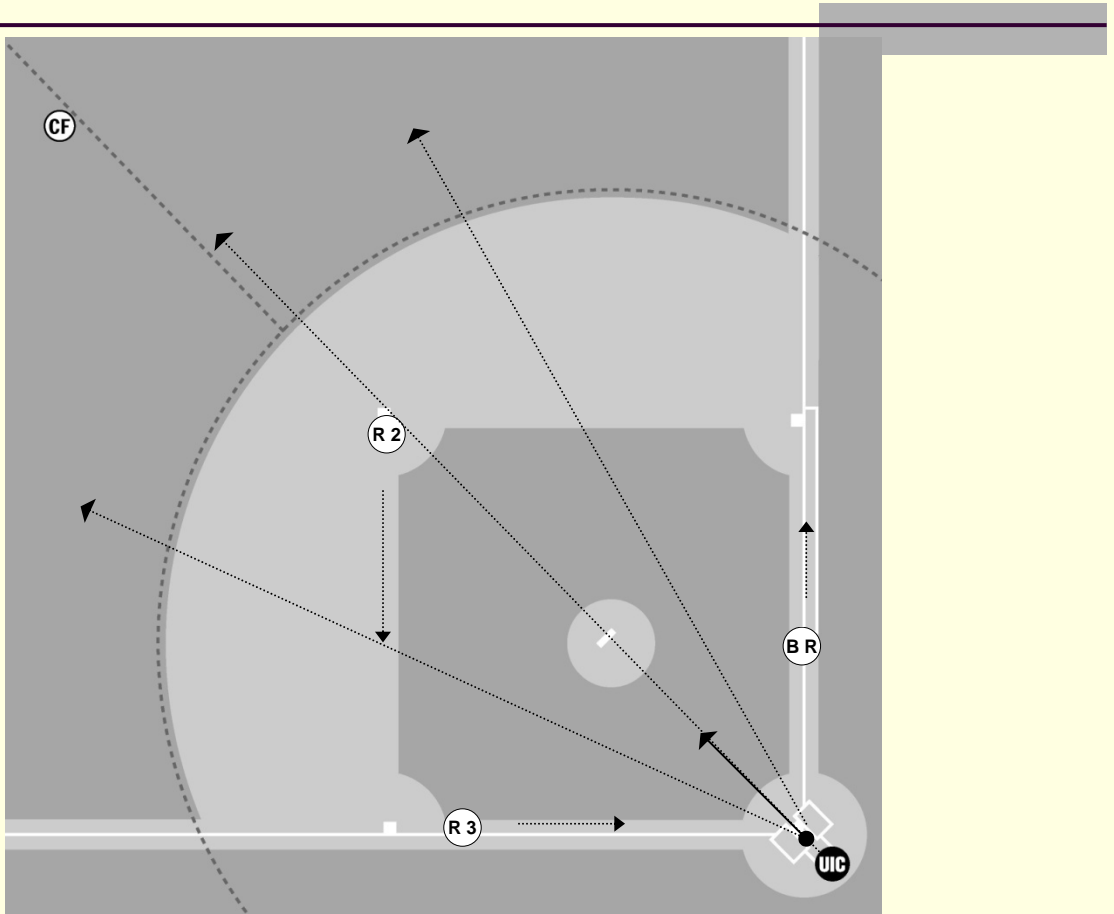

UIC The umpire moves towards the mound, checks the R3 home plate touch and then moves towards the base at which is the play

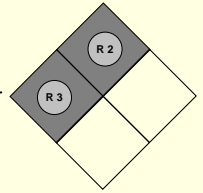

Situation #24 Fly ball to the outfield

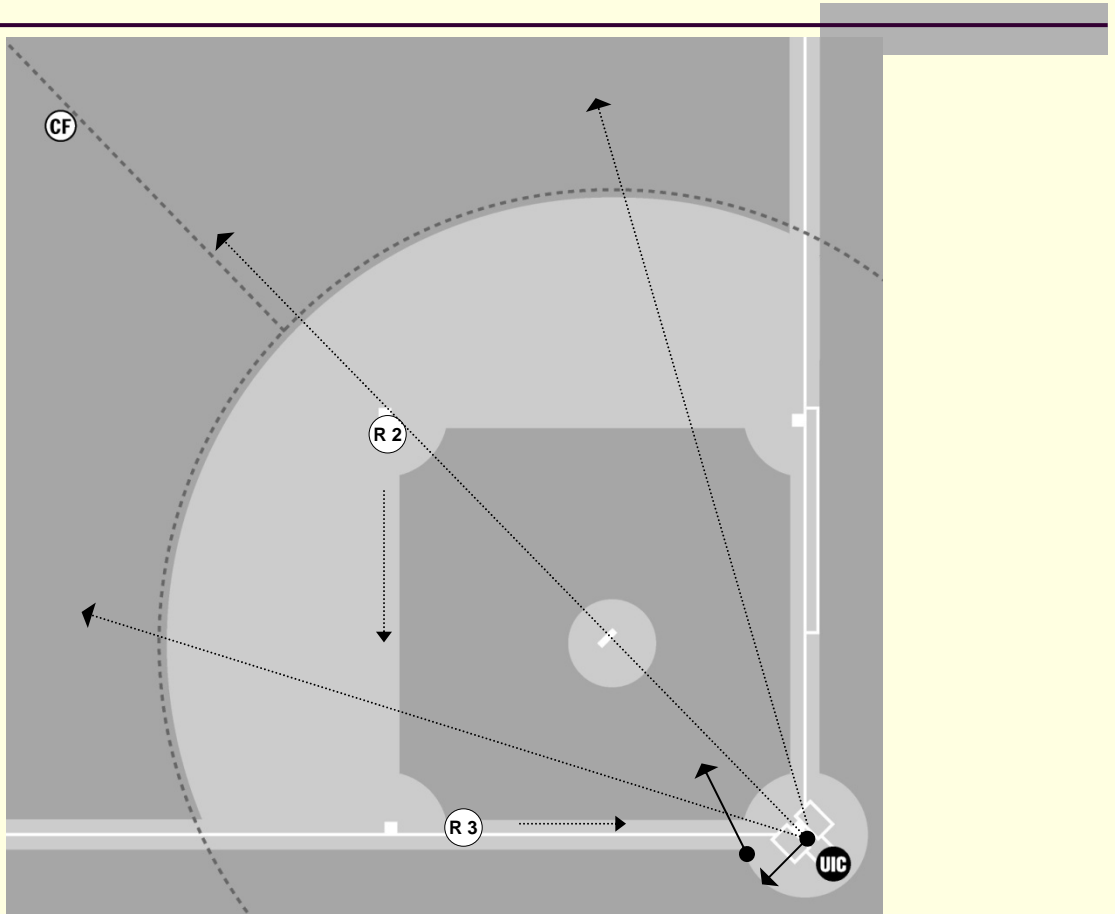

UIC The umpire must rule:

- Fair or foul
- Catch or no catch
- Watches the tags from third and second
- In case of play at home he stays there, otherwise checks the touch at home and then takes a few steps towards the infield for all possible plays at all bases.

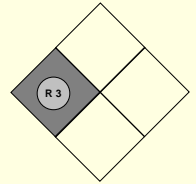
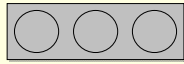

Situation #25 Ground ball to the infield

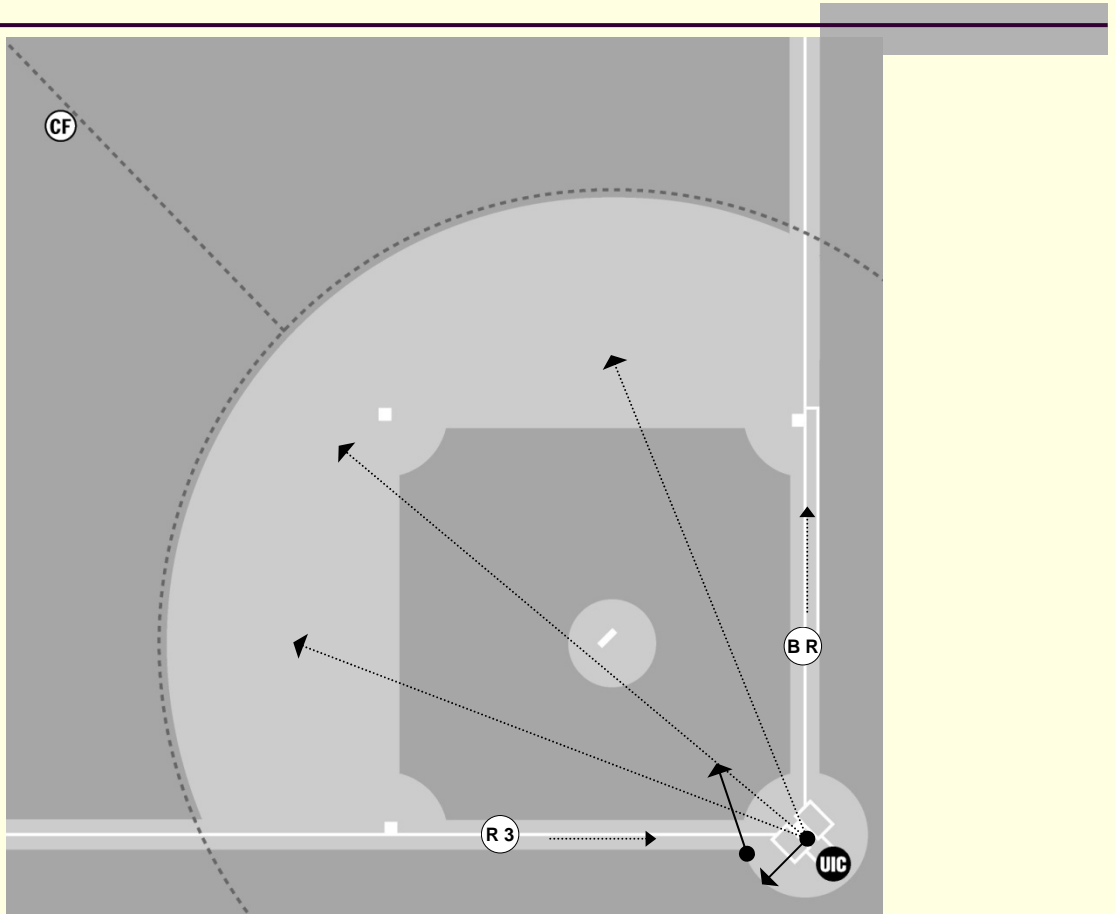

UIC The umpire reads the play and:

- If the first play is at home, he takes position for the play at home and then moves towards the infield for subsequent plays.
- If the first play is at first he moves towards the mound, spot checks the home plate touch and then moves towards the first.

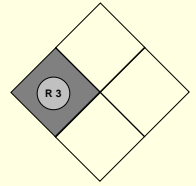

Situation #26 Fly ball to the outfield

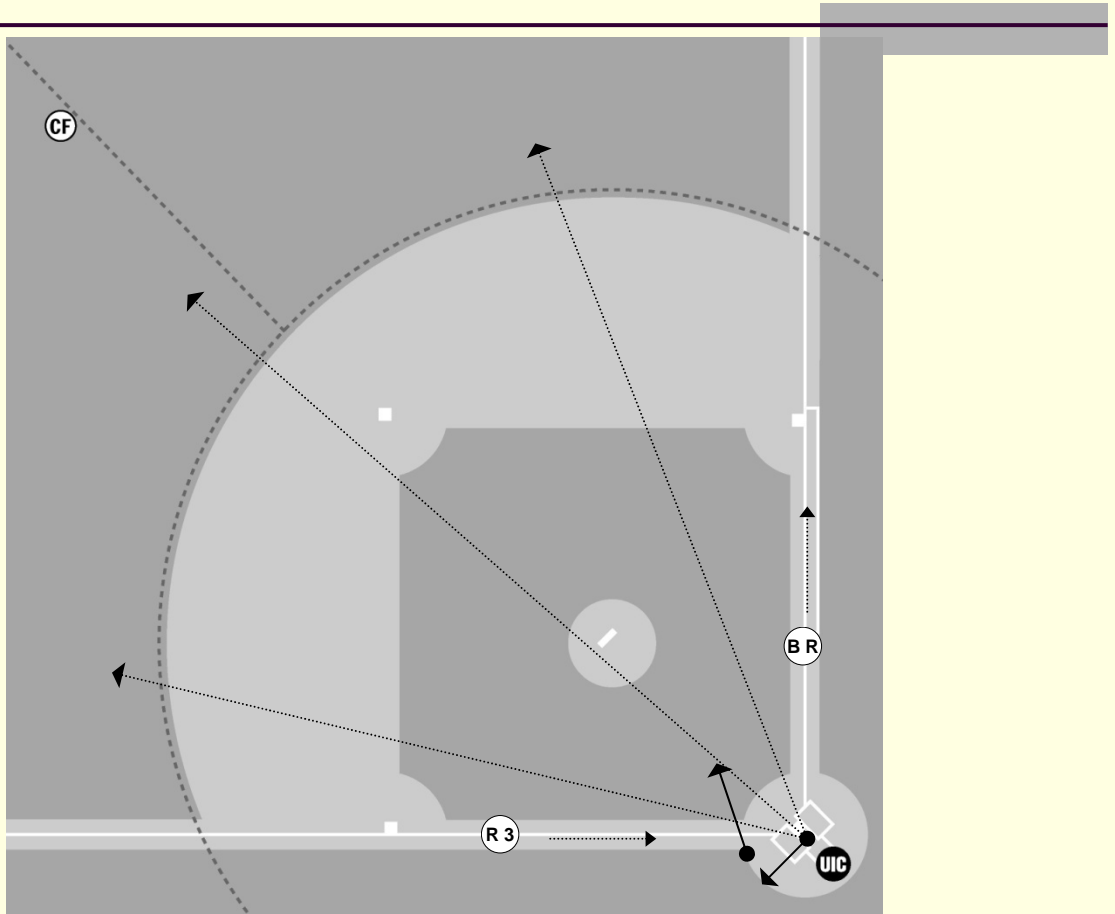

UIC The umpire must rule:

- Fair or foul
- Catch or no catch
- Watches the tag from third
- In case of play at home he stays there, otherwise checks the touch at home and then takes a few steps towards the infield for all possible plays at all bases.